



## 6-Pin DIP Optoisolators Logic Output

The MOC5007, MOC5008 and MOC5009 have a gallium arsenide IRED optically coupled to a high-speed integrated detector with Schmitt trigger output. Ideal for applications requiring electrical isolation, fast response time, noise immunity and digital logic compatibility.

- Guaranteed Switching Times —  $t_{on}$ ,  $t_{off}$   $4 < \mu s$
- Built-In ON/OFF Threshold Hysteresis
- High Data Rate, 1 MHz Typical (NRZ)
- Wide Supply Voltage Capability
- Microprocessor Compatible Drive
- **To order devices that are tested and marked per VDE 0884 requirements, the suffix "V" must be included at end of part number. VDE 0884 is a test option.**

### Applications

- Interfacing Computer Terminals to Peripheral Equipment
- Digital Control of Power Supplies
- Line Receiver — Eliminates Noise
- Digital Control of Motors and Other Servo Machine Applications
- Logic to Logic Isolator
- Logic Level Shifter — Couples TTL to CMOS

**MAXIMUM RATINGS** ( $T_A = 25^\circ C$  unless otherwise noted)

Rating	Symbol	Value	Unit
--------	--------	-------	------

### INPUT LED

Reverse Voltage	$V_R$	6	Volts
Forward Current — Continuous	$I_F$	60	mA
Peak		1.2	Amp
Pulse Width = 300 $\mu s$ , 2% Duty Cycle			
LED Power Dissipation @ $T_A = 25^\circ C$	$P_D$	120	mW
Derate above $25^\circ C$		1.41	mW/ $^\circ C$

### OUTPUT DETECTOR

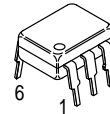
Output Voltage Range	$V_O$	0–16	Volts
Supply Voltage Range	$V_{CC}$	3–16	Volts
Output Current	$I_O$	50	mA
Detector Power Dissipation @ $T_A = 25^\circ C$	$P_D$	150	mW
Derate above $25^\circ C$		1.76	mW/ $^\circ C$

### TOTAL DEVICE

Total Device Power Dissipation @ $T_A = 25^\circ C$	$P_D$	250	mW
Derate above $25^\circ C$		2.94	mW/ $^\circ C$
Maximum Operating Temperature	$T_A$	–40 to +85	$^\circ C$
Storage Temperature Rang	$T_{stg}$	–55 to +150	$^\circ C$
Soldering Temperature (10 s)	$T_L$	260	$^\circ C$
Isolation Surge Voltage <sup>(1)</sup> (Peak ac Voltage, 60 Hz, 1 Second Duration)	$V_{ISO}$	7500	Vac(pk)

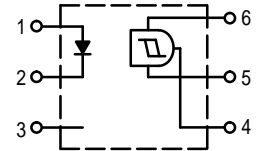
1. Isolation surge voltage is an internal device dielectric breakdown rating.  
For this test, Pins 1 and 2 are common, and Pins 4, 5 and 6 are common.

**MOC5007**  
**MOC5008**  
**MOC5009**



STANDARD THRU HOLE

### SCHEMATIC

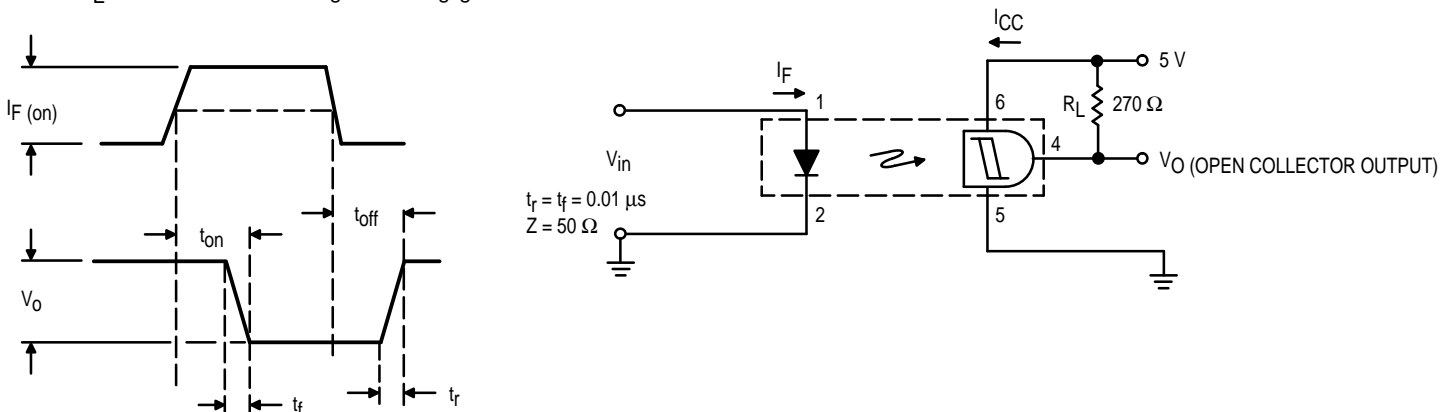


- PIN 1. ANODE  
2. CATHODE  
3. NC  
4. OPEN COLLECTOR  
OUTPUT  
5. GROUND  
6.  $V_{CC}$

**ELECTRICAL CHARACTERISTICS** ( $T_A = 25^\circ\text{C}$  unless otherwise noted)<sup>(1)</sup>

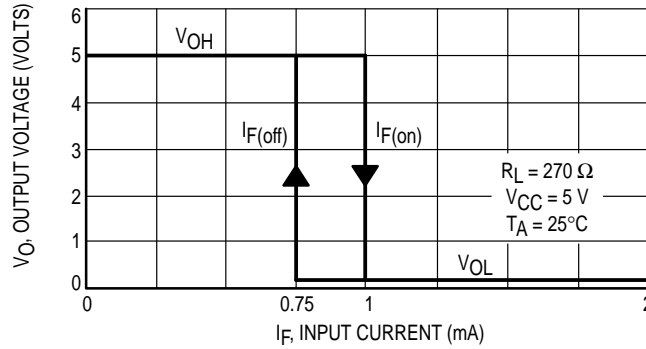
Characteristic	Symbol	Min	Typ <sup>1)</sup>	Max	Unit	
<b>INPUT LED</b>						
Reverse Leakage Current ( $V_R = 3\text{ V}$ , $R_L = 1\text{ M}\Omega$ )	$I_R$	—	0.05	10	$\mu\text{A}$	
Forward Voltage ( $I_F = 10\text{ mA}$ ) ( $I_F = 0.3\text{ mA}$ )	$V_F$	— 0.75	1.2 0.95	1.5 —	Volts	
Capacitance ( $V_R = 0\text{ V}$ , $f = 1\text{ MHz}$ )	$C$	—	18	—	$\mu\text{F}$	
<b>OUTPUT DETECTOR</b>						
Operating Voltage	$V_{CC}$	3	—	15	Volts	
Supply Current ( $I_F = 0$ , $V_{CC} = 5\text{ V}$ )	$I_{CC(\text{off})}$	—	1	5	$\text{mA}$	
Output Current, High ( $I_F = 0$ , $V_{CC} = V_O = 15\text{ V}$ )	$I_{OH}$	—	—	100	$\mu\text{A}$	
<b>COUPLED</b>						
Supply Current ( $I_F = I_{F(\text{on})}$ , $V_{CC} = 5\text{ V}$ )	$I_{CC(\text{on})}$	—	1.6	5	$\text{mA}$	
Output Voltage, Low ( $R_L = 270\ \Omega$ , $V_{CC} = 5\text{ V}$ , $I_F = I_{F(\text{on})}$ )	$V_{OL}$	—	0.2	0.4	Volts	
Threshold Current, ON ( $R_L = 270\ \Omega$ , $V_{CC} = 5\text{ V}$ )	$I_{F(\text{on})}$	—	1.2	1.6	$\text{mA}$	
	MOC5007	—	—	4		
	MOC5008	—	—	10		
	MOC5009	—	—	—		
Threshold Current, OFF ( $R_L = 270\ \Omega$ , $V_{CC} = 5\text{ V}$ )	$I_{F(\text{off})}$	0.3	0.75	—	$\text{mA}$	
	MOC5007	0.3	—	—		
	MOC5008, 5009	—	—	—		
Hysteresis Ratio ( $R_L = 270\ \Omega$ , $V_{CC} = 5\text{ V}$ )	$\frac{I_{F(\text{off})}}{I_{F(\text{on})}}$	0.5	0.75	0.9		
Isolation Voltage <sup>(2)</sup> 60 Hz, AC Peak, 1 second, $T_A = 25^\circ\text{C}$	$V_{ISO}$	7500	—	—	$\text{Vac(pk)}$	
Turn-On Time	$R_L = 270\ \Omega^{(3)}$ $V_{CC} = 5\text{ V}$ , $I_F = I_{F(\text{on})}$ $T_A = 25^\circ\text{C}$	$t_{on}$	—	1.2	4	$\mu\text{s}$
Fall Time		$t_f$	—	0.1	—	
Turn-Off Time		$t_{off}$	—	1.2	4	
Rise Time		$t_r$	—	0.1	—	

1. Always design to the specified minimum/maximum electrical limits (where applicable).
2. For this test, IRED Pins 1 and 2 are common and Output Gate Pins 4, 5, 6 are common.
3.  $R_L$  value effect on switching time is negligible.

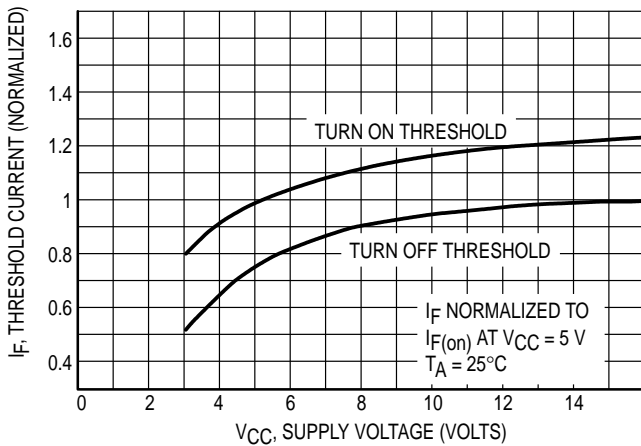


**Figure 1. Switching Test Circuit**

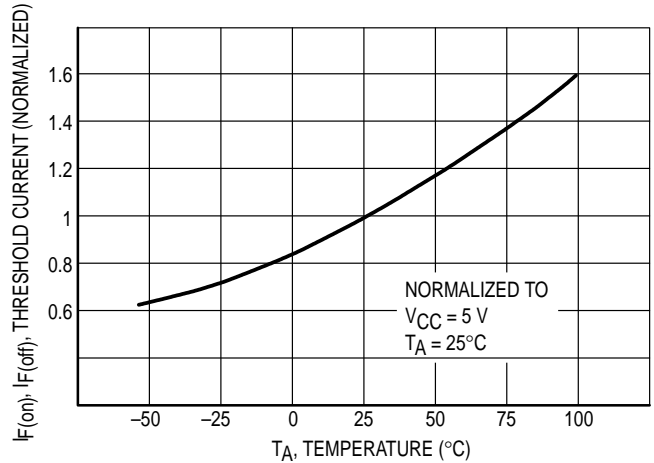
**TYPICAL CHARACTERISTICS**



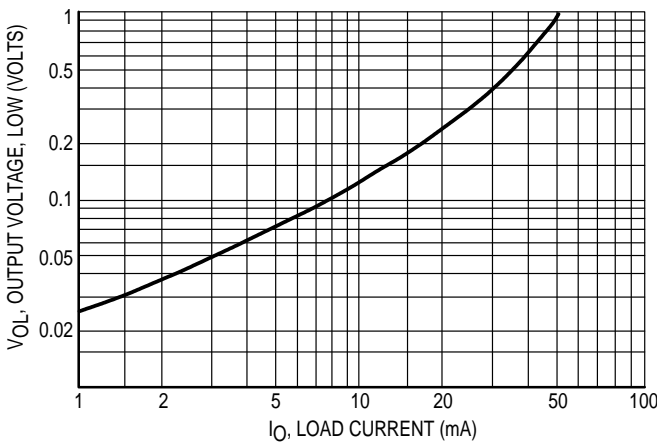
**Figure 2. Transfer Characteristics for MOC5007**



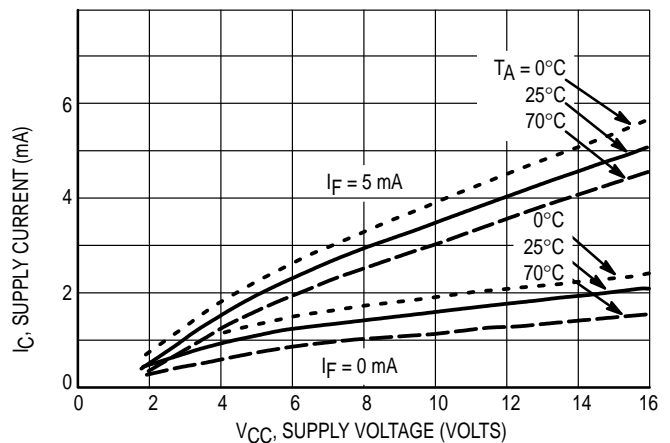
**Figure 3. Threshold Current versus Supply Voltage**



**Figure 4. Threshold Current versus Temperature**

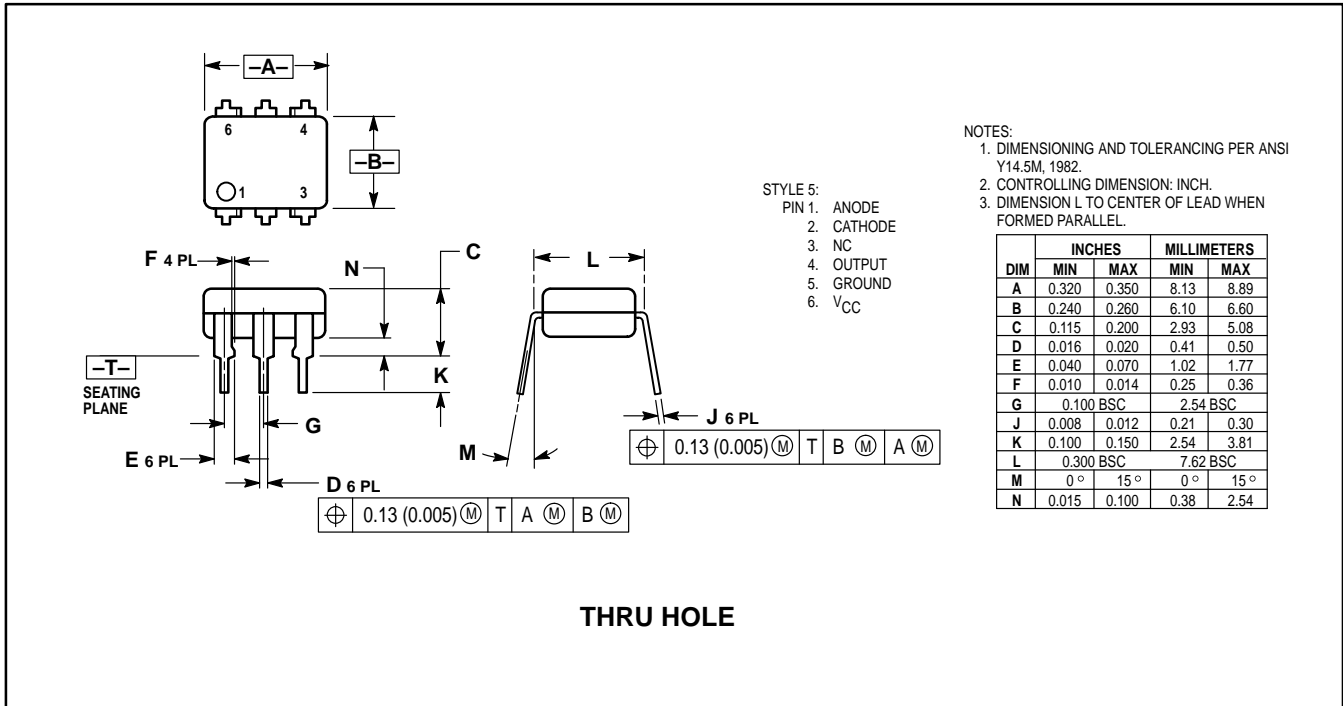


**Figure 5. Output Voltage, Low versus Load Current**

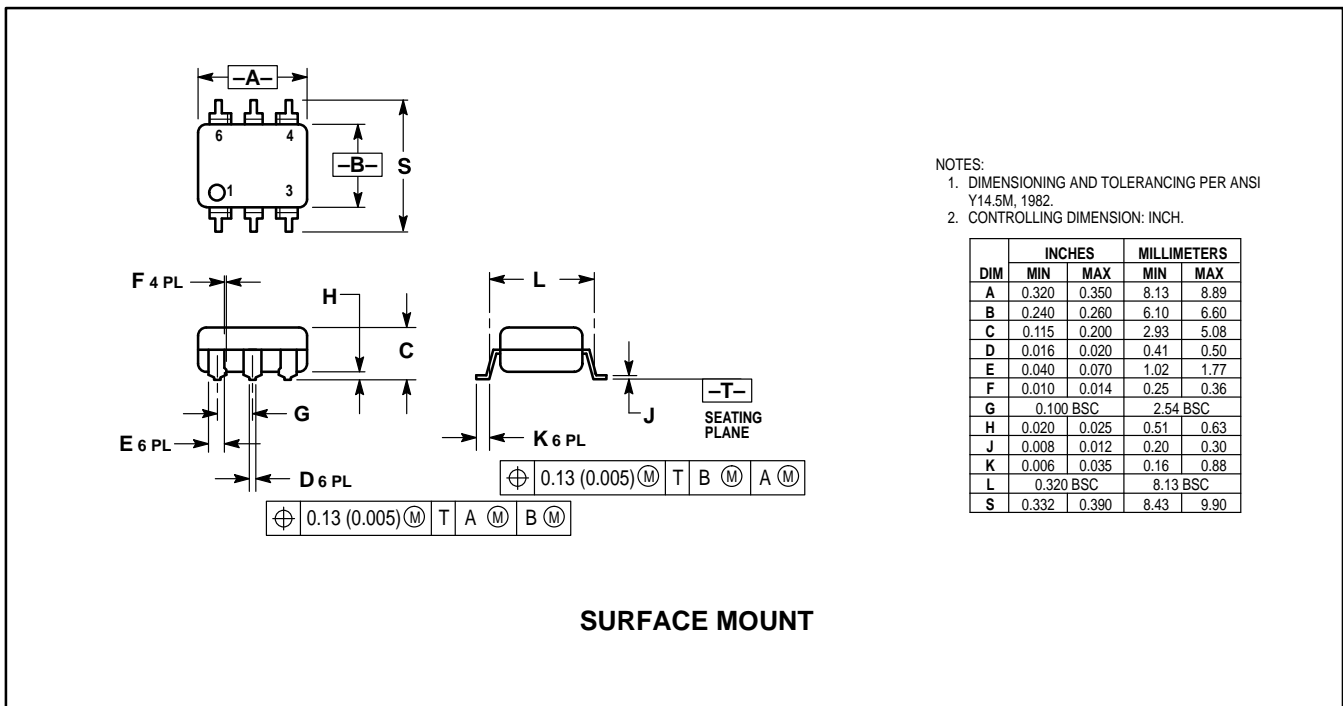


**Figure 6. Supply Current versus Supply Voltage**

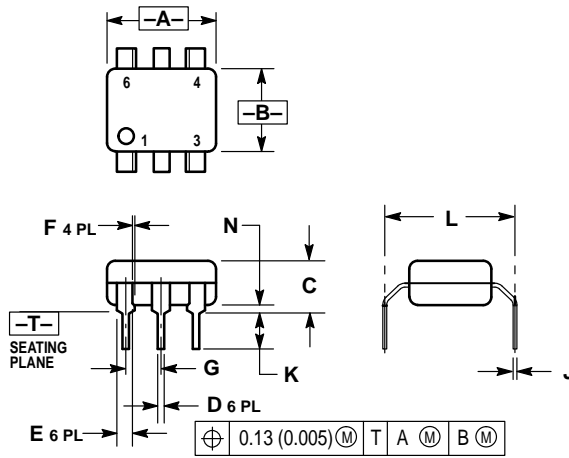
**PACKAGE DIMENSIONS**



**THRU HOLE**



**SURFACE MOUNT**



- NOTES:
1. DIMENSIONING AND TOLERANCING PER ANSI Y14.5M, 1982.
  2. CONTROLLING DIMENSION: INCH.
  3. DIMENSION L TO CENTER OF LEAD WHEN FORMED PARALLEL.

DIM	INCHES		MILLIMETERS	
	MIN	MAX	MIN	MAX
A	0.320	0.350	8.13	8.89
B	0.240	0.260	6.10	6.60
C	0.115	0.200	2.93	5.08
D	0.016	0.020	0.41	0.50
E	0.040	0.070	1.02	1.77
F	0.010	0.014	0.25	0.36
G	0.100 BSC		2.54 BSC	
J	0.008	0.012	0.21	0.30
K	0.100	0.150	2.54	3.81
L	0.400	0.425	10.16	10.80
N	0.015	0.040	0.38	1.02

**0.4" LEAD SPACING**

#### **DISCLAIMER**

FAIRCHILD SEMICONDUCTOR RESERVES THE RIGHT TO MAKE CHANGES WITHOUT FURTHER NOTICE TO ANY PRODUCTS HEREIN TO IMPROVE RELIABILITY, FUNCTION OR DESIGN. FAIRCHILD DOES NOT ASSUME ANY LIABILITY ARISING OUT OF THE APPLICATION OR USE OF ANY PRODUCT OR CIRCUIT DESCRIBED HEREIN; NEITHER DOES IT CONVEY ANY LICENSE UNDER ITS PATENT RIGHTS, NOR THE RIGHTS OF OTHERS.

#### **LIFE SUPPORT POLICY**

FAIRCHILD'S PRODUCTS ARE NOT AUTHORIZED FOR USE AS CRITICAL COMPONENTS IN LIFE SUPPORT DEVICES OR SYSTEMS WITHOUT THE EXPRESS WRITTEN APPROVAL OF THE PRESIDENT OF FAIRCHILD SEMICONDUCTOR CORPORATION. As used herein:

1. Life support devices or systems are devices or systems which, (a) are intended for surgical implant into the body, or (b) support or sustain life, and (c) whose failure to perform when properly used in accordance with instructions for use provided in the labeling, can be reasonably expected to result in a significant injury of the user.
2. A critical component in any component of a life support device or system whose failure to perform can be reasonably expected to cause the failure of the life support device or system, or to affect its safety or effectiveness.